

### **3.3 APPROACH TO NETWORKX ARCHITECTURE, CONVERGENCE, INTEROPERABILITY, AND EVOLUTION ((L.34.1.3.3), (M.2.1.1 (D)))**

***Government Agencies are supported on many disparate networks. Qwest's converged network platform provides integrated access to Agency locations for secure voice, video and data communication.***

Qwest has a comprehensive approach to meet the long-term networking requirements of Agencies. We have invested in our infrastructure as well as planning and engineering talent to deploy a modern networking platform that provides our customers a full range of services on a converged transport platform.

Qwest has successfully overcome the challenge of merging an incumbent local provider and a traditional long-distance company. Our planning, product management, engineering, and operations organizations today represent a unified structure with experience meeting Government requirements end-to-end.

Qwest's entire network focus is based on an *any-access* approach to a set of converged network services. Qwest has created an architecture that supports, with effective Quality of Service (QoS) mechanisms, a full spectrum of access alternatives, including traditional TDM-based integrated access, Asynchronous Transfer Mode (ATM) and Frame Relay (FR) virtual circuits, and Internet Protocol (IP)-based access convergence to our data and voice services.

Based on a private Multi-Protocol Label Switching (MPLS) core, our architecture already supports all of our IP-based services, including a

significant percentage of our legacy Inter-Exchange Carrier (IXC) voice traffic, and is fully integrated with our ATM and FR network creating one environment for data, voice, and Voice over Internet Protocol (VoIP) services.

With a network based on leading-edge MPLS technology, new services can be added in a modular fashion at the edge. Each of these edge services inherits the security, reliability, and other features of the core network. Qwest has successfully deployed and operates integrated Operational Support Systems (OSS). This capability provides improved network and configuration management based on streamlined operational control of network and application platforms.

In fact, Qwest has the Next Generation network *now*, with all of our IP-based services—including voice and VoIP—riding over a common, robust, high-capacity backbone with the QoS and capacity planning necessary to ensure service quality for all application types.

### **3.3.1 Approach for Integrated Access (L.34.1.3.3(a))**

[Redacted content]

[REDACTED]

[REDACTED]

[REDACTED] depicts the overall Qwest architecture for providing transport services to Agencies. Customer applications, whether they are voice, data, or a combination are all supported by a full range of Service Enabling Devices (SEDs). [REDACTED]

[REDACTED]

[REDACTED]

[REDACTED]

[REDACTED]

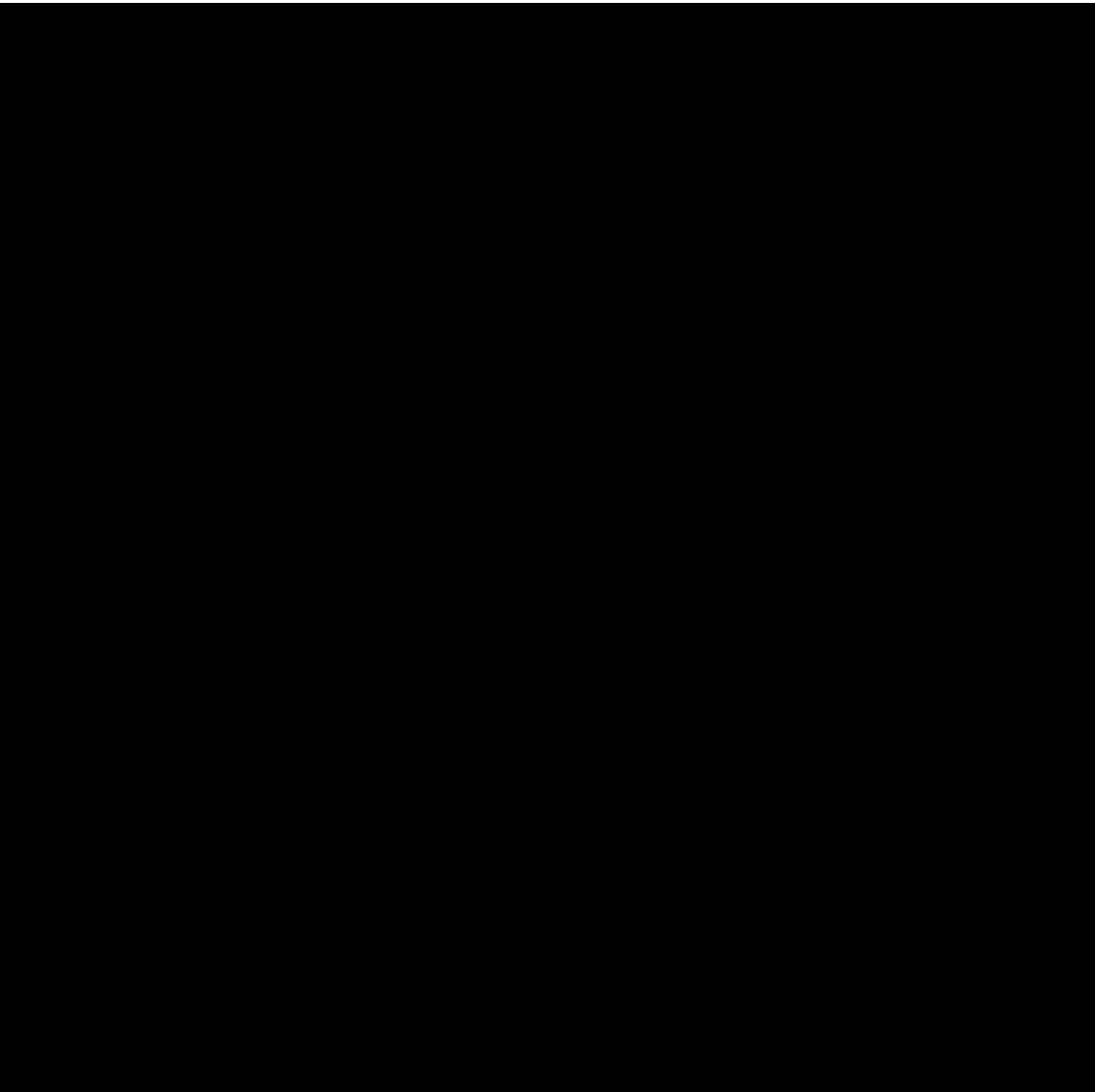

### **3.3.1.1 Traditional Time Division Multiplexed (TDM) Integrated Access**

TDM access integration uses traditional Digital Cross-Connect (DCS) technology and channelized circuits. Various access channels are TDM-segmented at the premise with the use of a SED and in the network at the DCS. From the DCS, channels dedicated to various telecommunications services such as VS, TFS, FRS, ATMS, VOIPTS, IPTeIS, IPS, NBIPVPNS, L2VPNS, and EthS are passed on to the necessary sub-network.

For traditional Time Division Multiplexed (TDM) Integrated Access, Qwest provides multiplexing on T-1, DS-3, and OC-n access circuits. As an example, the homogeneous nature of our Synchronous Optical Network (SONET) network allows Qwest to:

[REDACTED]

TDM provides fixed and guaranteed performance to each service provided over the dedicated access. Agencies can define the size of access to each network service to match the different performance requirements of their applications.

**3.3.1.2 Frame Relay, ATM, and xDSL Access**

TDM provides a proven, robust access method for telecommunications services but comes with the limitation that bandwidth allocation is statically defined. The architecture of the Qwest network allows for a more flexible, next generation approach. Any dedicated circuit, even if it is multiplexed out of a higher order circuit, can provide access to many Qwest services, each with QoS mechanisms to enable different applications to use the same

access circuit. Dedicated access from an Agency location can terminate in the Qwest ATM/FR edge devices allowing applications such as voice and video to use QoS, ensuring proper application performance.

In addition, Qwest has introduced a significant new capability, enabling access to the hundreds of regional ATM and FR networks provided by Qwest and other ILECs and Competitive Local Exchange Carriers (CLECs). Each of these networks is interconnected to the Qwest integrated ATM/FR network.

[REDACTED]  
[REDACTED] These interconnections enable Agencies to use Layer 2 private access methods to all of Qwest's data services. This significantly reduces Agency costs and improves the performance of Agency applications.

Access to regional Layer 2 networks allows a new scope of capabilities for Agencies and facilitates a key objective of the Federal Enterprise Architecture. For example, by using Qwest, Agencies can:

[REDACTED]  
[REDACTED]  
[REDACTED]  
[REDACTED]  
[REDACTED]  
[REDACTED]  
[REDACTED]  
[REDACTED]  
[REDACTED]  
[REDACTED]  
[REDACTED]  
[REDACTED]  
[REDACTED]  
[REDACTED]  
[REDACTED]  
[REDACTED]

[REDACTED]

The Qwest IP/MPLS network architecture enables interoperability among different Agency locations, regardless of the mix of access types used

[REDACTED]

For international access, Qwest uses a combination of owned facilities and teaming carriers. Qwest's ATM and FR services extend to Points of Presence (POPs) [REDACTED]. Existing supplier relationships allow Qwest to extend ATM and FR access to the major U.S. Territories and non-domestic locations using standard Network to Network Interfaces (NNIs). These relationships allow Qwest to offer Agencies the highest value service through reduced provisioning intervals, faster local response to service troubles and best access cost. All suppliers interconnect with Qwest at multiple POPs allowing Qwest to take end-to-end responsibility for the capacity planning, provisioning, network monitoring, and trouble management.

The Qwest ATM/FR service provides multiple QoS classes to support Agency voice, video, and data applications with different performance

requirements. We support four ATM and three FR QoS classes. Agencies can use the QoS classes to separate traffic and ensure application performance. Qwest will provide the pre-sales engineering support to understand Agency application needs and design solutions to meet performance requirements.

Our ATM/FR service has no performance-limiting gateways between these two services. Using Frame Relay Forum FRF.8 service interworking, any ATM location can communicate with any FR location with QoS maintained end-to-end.

[Redacted content]



[REDACTED]

Qwest assumes complete end-to-end responsibility for capacity planning, provisioning, network monitoring, and trouble management regardless of the type of access used to connect to our network.

**3.3.1.3 Emerging Integrated Access**

Most access technologies are migrating to Ethernet on the network side (e.g., Metro Ethernet services, WiFi, WiMAX). Qwest leads the market in providing Ethernet services in our own ILEC region and nationwide, using ILEC and CLEC supplier access. [REDACTED]

[REDACTED]

[Redacted text block]

[Redacted text block]

[REDACTED]

[REDACTED] It is expected that Ethernet technologies will increase to 100 Gbps in the near future.

Qwest's recently completed acquisition of OnFiber Communications will enable significant expansion of cost-effective Ethernet access to the Qwest Network.

Very similar to the approach for DSL, Ethernet will be provided by the Qwest ILEC, the Qwest CLEC in [REDACTED], and Ethernet services from multiple ILECs and CLECs. [REDACTED]

[REDACTED]

[REDACTED]

[REDACTED]

[REDACTED]

[REDACTED]

[REDACTED]

[REDACTED]

[REDACTED]

[REDACTED]

Worldwide Interoperability for Microwave Access (WiMAX) is a new and exciting technology that holds open the promise of broadband (approximately 1 Mbps to 5 Mbps) virtually anywhere. Qwest has performed several successful field trials with WiMAX technology to investigate its use as a dedicated point-to-point access method as well as a shared multi-point access method. In general, WiMAX is very similar to Ethernet services in that WiMAX standards provide for QoS mechanisms, and the network interface into WiMAX is via Ethernet connections. [REDACTED]

[REDACTED]

[REDACTED]

[REDACTED]

Ethernet access, whether by copper, fiber, or Radio Frequency (RF), is a Layer 2 access method with significant similarities to ATM and FR access. Qwest's experience in providing legacy Layer 2 access to our data services network gives us the in-house expertise to quickly deliver high-quality, multimedia service convergence using emerging Layer 2 technologies. [REDACTED] shows how standards such as 802.1p will enable Agencies to leverage the cost benefits of Ethernet access while maintaining a QoS level ensuring application performance.

As with all other access methods, Qwest takes complete responsibility for the end-to-end planning, engineering, provisioning, monitoring and trouble management for Ethernet access.

[REDACTED]

#### ***3.3.1.4 Network and Service Internetworking Functions and Platforms used to Enable Integration***

Qwest implements a standard set of packet-based traffic classification and traffic management (policing, shaping, queuing, and scheduling) policies on access, aggregation, and core network elements. [REDACTED]

[REDACTED]

**Figure 3.3.1-3a. Qwest Integrated Access Methods, Services, and Platforms**

Integrated Access Method		
TDM	[REDACTED]	[REDACTED]
Layer 2 (FR, ATM, DSL)	[REDACTED]	[REDACTED]
Layer 2 (Ethernet, WiFi, WiMAX)	[REDACTED]	[REDACTED]
Layer 2.5 (VPN services)	[REDACTED]	[REDACTED]
Layer 3 (Internet)	[REDACTED]	[REDACTED]

[REDACTED]

[REDACTED]

[REDACTED]

[REDACTED]

[REDACTED]

[REDACTED]

[REDACTED]

[REDACTED]

With the capability of the Qwest MPLS network to provide both Layer 2 and Layer 3 services, the evolution of integrated access is directly related to this industry-wide and ever improving technology.

**3.3.2 Overall Network Architecture (L.34.1.3.3 (b))**

Qwest built our network architecture from the ground up to focus on convergence and interoperability, and to provide a flexible core foundation for the evolution of new Next Generation services. Qwest's architecture

leverages our nationwide homogeneous fiber optic transport network to provide leading-edge converged voice and data services using a variety of access methods.

[Redacted text block]

[Large redacted text block]

[REDACTED]

This design allows for deployment and support of new and emerging services, such as Ethernet transport.

**Figure 3.3.2-2. Qwest SONET Protection.** Qwest's highly available four fiber bi-direction line switched ring (4F-BLSR) fully route diverse design.

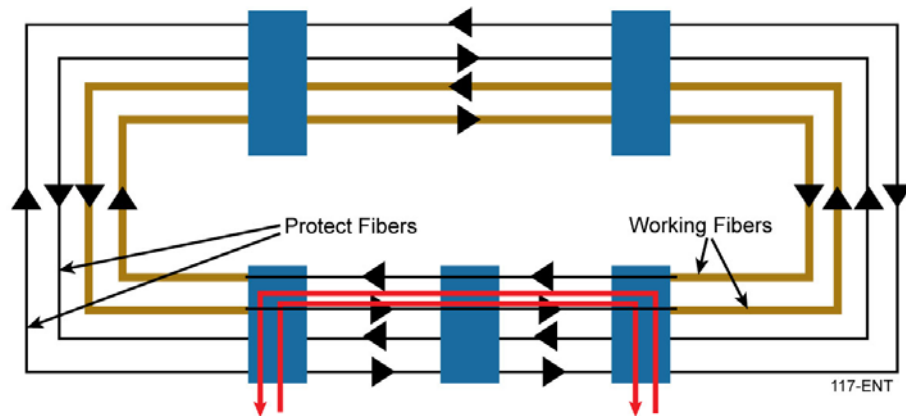

Qwest breaks down network stovepipes by our *any-access* approach to services such as Internet, MPLS VPN, VoIP and integrated ATM/FR. Qwest has engineered each of these access methods to enable true convergence by providing the right QoS to the specific application. **Figure** [REDACTED] highlights the advantages of Qwest's end-to-end network architecture.

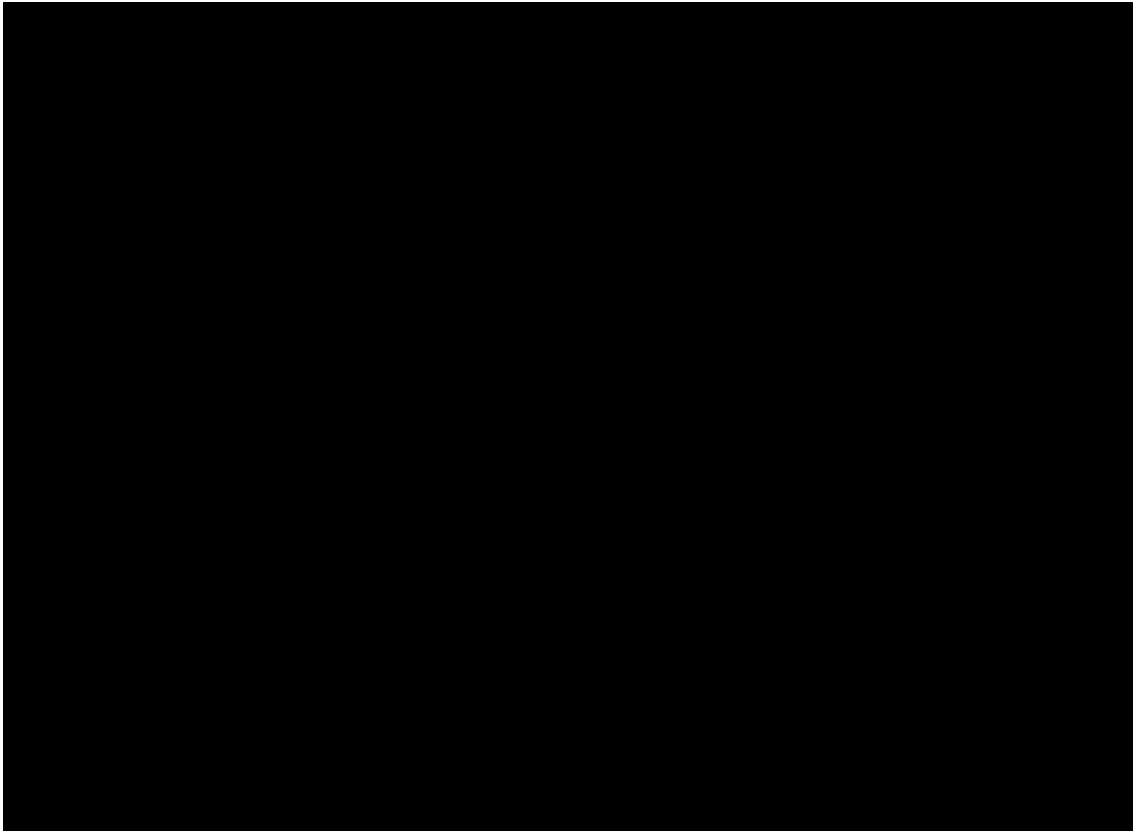

On the Qwest converged network, our Private MPLS core provides the data transport for all of our data services. Edge-provided services are layered onto the MPLS core to support private VPNs, Internet services, VoIP and Public Switched Telephone Network (PSTN) connections.

Qwest integrates traditionally isolated ATM/FR services to provide flexible access to all of Qwest's IP-based services such as Internet, private IP VPNS and VoIP. Qwest's ATM/FR interconnections to ILECs extend our reach to deliver traditional data or IP services throughout the Continental U.S. (CONUS). Qwest's interconnections to international ATM and FR suppliers to offer Agencies global access to the Qwest converged core.

Agencies can benefit from the rich set of converged communication applications that are enabled by the Qwest network architecture. A combination of TDM switches, VoIP switches, service platforms and signaling



nodes work in concert to deliver Networx services to Agencies. For example, toll-free calls placed from a VoIP phone, a local Plain Old Telephone Service (POTS) phone, and a Private Branch Exchange (PBX) using ISDN PRI are processed by the same Service Control Point (SCP). Qwest strives to provide a consistent experience by building a service once and allowing Agencies to choose the type of access best suited for their needs. Qwest is currently implementing the capability to extend feature control from the traditional telephone handset to a more feature rich and user friendly Graphical User Interface (GUI) for voice services.

[REDACTED]

[REDACTED] All switches are connected to each other via multiple, redundant paths to ensure service availability and reliability. The network uses a state-of-the-art dynamic call routing system and is able to re-route and deliver a call through any other path in the event of a failed network path.

Access into the long-distance switches can be accomplished via the following methods:

[REDACTED]

[REDACTED] provides an overview of the Qwest voice network.

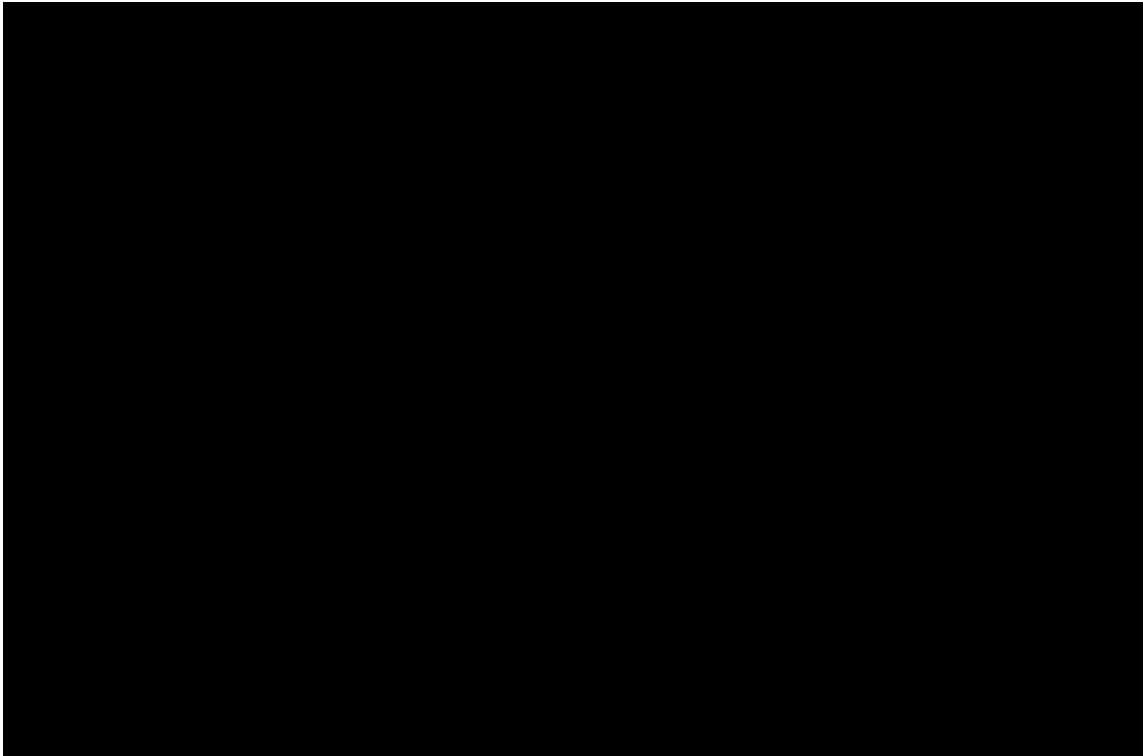

Both IP and TDM local dial tone is available from Qwest. These systems support numerous traditional voice features such as voice mail, call forwarding or three-way calling. Qwest's IPTeIS adds advanced capabilities such as Outlook integration and a Web interface. [REDACTED]

[REDACTED]  
[REDACTED] Access into the local switches frequently uses one of the following methods:

[REDACTED]

[REDACTED]

[REDACTED]

All components of the voice network are carrier-grade, meaning they [REDACTED]. The robustness of the combined architecture design is meant to improve on the overall network

availability. The voice network is also designed to be non-blocking during peak use.

Switch network signaling is transported by the Signaling System 7 (SS7) network, which provides voice call signaling and supports database transactions between service platforms and switches. The SS7 network uses redundant links where each link follows a totally different path than its paired mate. Each link has a maximum utilization [REDACTED], so in the event of a failure, the mated link can handle the failed link's load. Each system in the SS7 network has fully redundant hardware and a geographically redundant mate.

[REDACTED]. In the event of link failure, traffic is re-routed within milliseconds. The equipment and facilities in the IP/MPLS core are fully redundant.

Convergence extends to our network operations. Qwest uses separate centralized Network Operations Centers (NOCs) for all data, transport and voice services. Each NOC has a geographically diverse back-up location.

### **3.3.3 Supporting Evolution, Convergence, and Ensuring Interoperability (L.34.1.3.3 (c))**

Network evolution, convergence, and interoperability are all key foundations of the design of the Qwest Network and our IP/MPLS core. Technological evolution is supported through the introduction of high-capacity platforms that support multiple services on the MPLS core to create a unified packet transport mechanism. [REDACTED] provides a graphical overview of the Qwest network architecture.

### 3.3.3.1 Optical Technology

Improved performance management for emerging services is realized through four notable evolutions expected in the wavelength technology area:

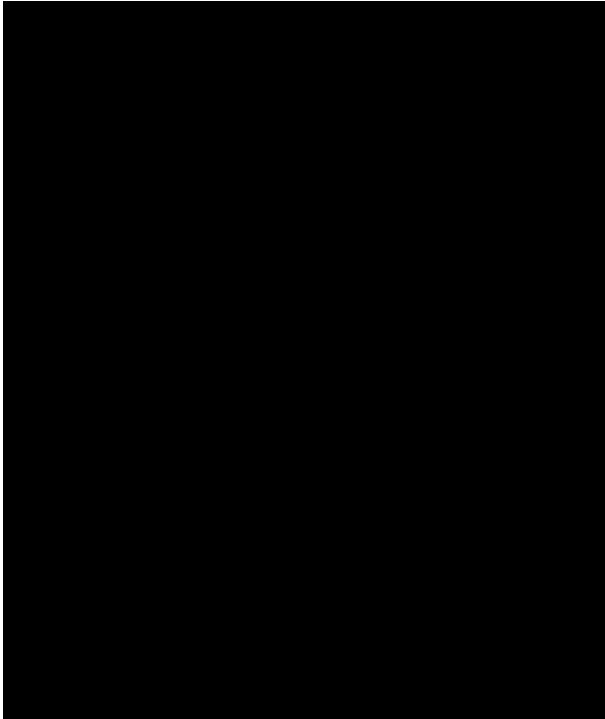

[Redacted text block containing multiple lines of blacked-out content]

[REDACTED]

### **3.3.3.2 Reserved**

### **3.3.3.3 Wireless/Wireline Integration**

The Qwest architecture also supports convergence in the area of wireless/wireline integration. [REDACTED]

[REDACTED] are the worldwide standards for the creation, delivery and playback of multimedia over 3rd generation, high-speed wireless networks. The 3GPP Release 5 IP Multimedia Subsystem (IMS) abstracts the access method from the application. The standard also provides for other common systems such as the Home Subscriber Server (HSS) to coordinate user profile and application data. This simplifies application development by removing authentication, user profile management, and end-point control from the application. Complying with this standard allows users to access applications through third parties. This capability is analogous to roaming, but provides users a full suite of services via third-party access. [REDACTED]

[REDACTED]

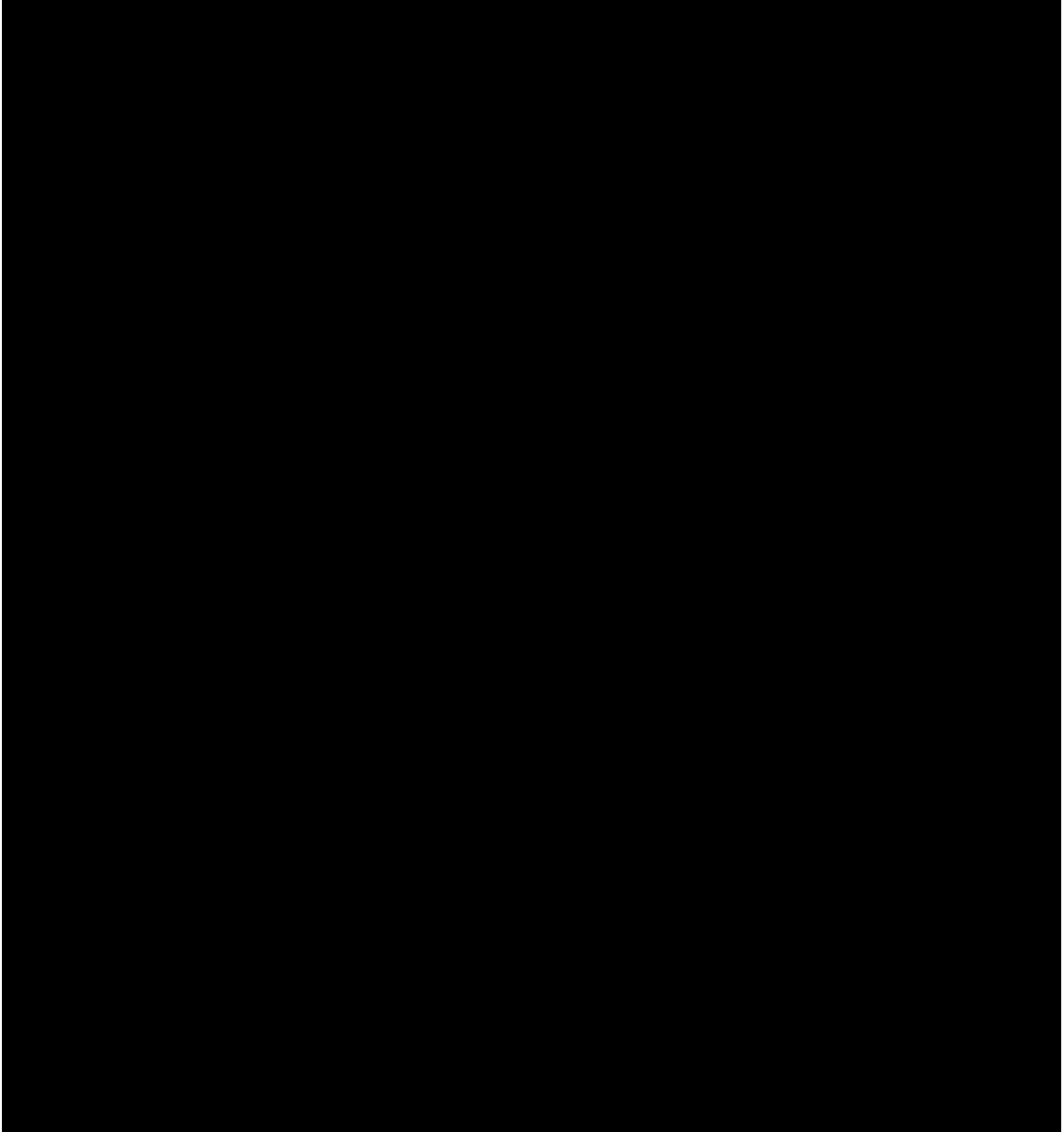

As the Qwest network evolves to IMS, Qwest maintains interoperability to legacy technologies through standard interfaces. 







[REDACTED]

The Qwest One Number Service is a deployed Qwest intellectual property that allows a user to receive calls on either the wireline or wireless phone, depending on the registration status of the wireless device and on user preference. This capability is enhanced by a common mailbox that provides users access to a single repository of messages.

Most access technologies are currently optimized to a particular application. While all of these access technologies could be integrated into a single platform, the cost of such a platform would be at a premium. Additionally, technology lifecycles must be taken into consideration. The evolution of access technologies is advancing at an unprecedented rate. Currently, many access technologies are becoming obsolete within 3 to 5 years.

[REDACTED]

Most access technologies are migrating to Ethernet on the network side. [REDACTED]

[REDACTED]

Our expectation is that DSL-type technologies will continue to evolve with faster and faster connections over existing copper pairs becoming available. At the same time, the DSLAM itself will move to an IP-based platform, and the interface between a DSL provider and Qwest will become based on Ethernet standards.

Ethernet local access, or metro optical Ethernet, is becoming more pervasive and is already beginning to replace traditional TDM access for MAN connectivity and Layer 3 services access.

WiMAX services will follow a similar pattern from initial availability to coverage in all major metropolitan areas within the next few years. [REDACTED]

[REDACTED]

[REDACTED] With the standard designed to provide Ethernet-like QoS capabilities and Ethernet hand-off, WiMAX may evolve into the wireless mobility service to which its older cousin WiFi provides a glimpse.

[REDACTED]

#### **3.3.3.4 Service Delivery**

Qwest's service delivery model supports multiple types of customer requirements. Qwest's approach for network architecture evolution guides our investments and provides the overall direction for our technology evolution and services convergence. The service delivery model allows us to assess interoperability impacts of service layer changes. At the core of Qwest IP-centric approach are the optical transport and IP/MPLS networks. The service



delivery model [REDACTED]

[REDACTED] It is this layered approach that enables users to request both network resources, such as bandwidth, and application resources such as call control, security services, messaging and conferencing.

### **3.3.3.5 Model for Services Convergence**

Qwest has established a model for a migration to a packet-oriented infrastructure with a comprehensive control plane that links the MPLS core to the optical transport environment.

Using this model, Qwest has already:

[REDACTED]

[Redacted text block containing multiple lines of blacked-out content]

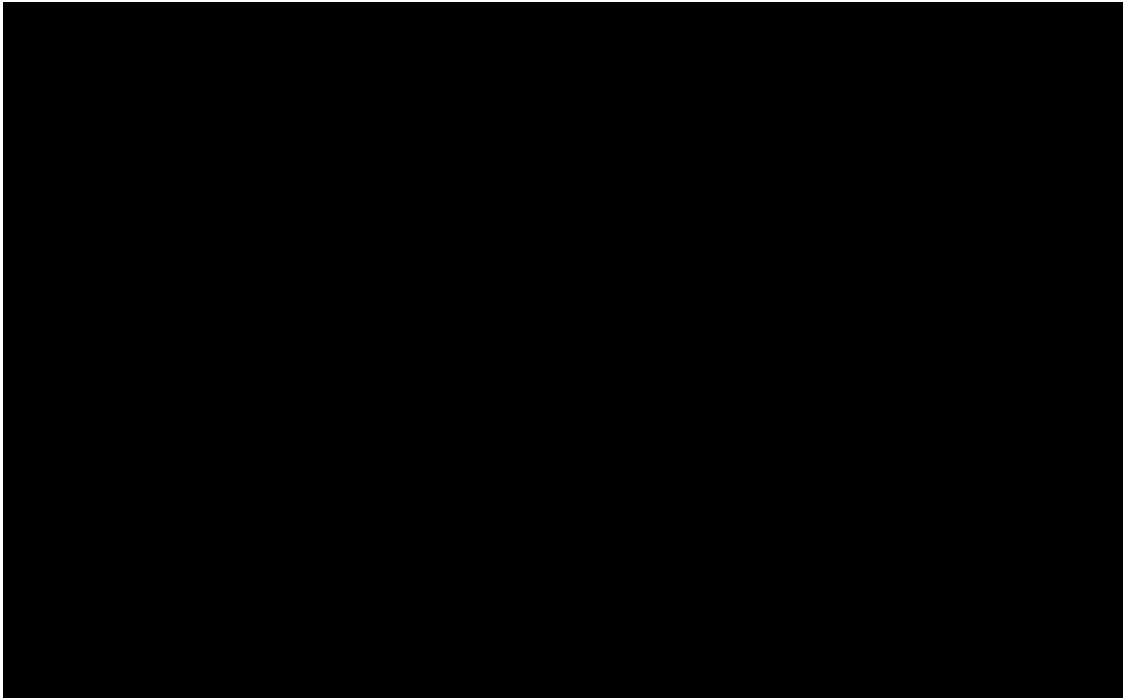

Qwest is migrating to a packet-centric infrastructure to include access integration methodologies. The following table summarizes the applicable packet-centric services, the activity, and milestone dates of the related activities.

**Figure 3.3.3-3a. Qwest Architectural Evolution of Networx Services**

Service	[REDACTED]	[REDACTED]
FR, ATM, IPS, PLS, NBIPVPN	[REDACTED]	[REDACTED]
VOIPTS, IPTeIS, CIPS	[REDACTED]	[REDACTED]
EthS	[REDACTED]	[REDACTED]
L2VPN	[REDACTED]	[REDACTED]
FR, ATM, IPS, PLS, NBIPVPN	[REDACTED]	[REDACTED]
VOIPTS, IPTeIS, CIPS	[REDACTED]	[REDACTED]
EthS	[REDACTED]	[REDACTED]
L2VPN	[REDACTED]	[REDACTED]
FR, ATM, IPS, PLS, NBIPVPN	[REDACTED]	[REDACTED]
VOIPTS, IPTeIS, CIPS	[REDACTED]	[REDACTED]
EthS	[REDACTED]	[REDACTED]
L2VPN	[REDACTED]	[REDACTED]

Service	[REDACTED]	[REDACTED]
FR, ATM, IPS, PLS, NBIPVPN	[REDACTED]	[REDACTED]
VOIPTS, IPTeIS, CIPS	[REDACTED]	[REDACTED]
EthS	[REDACTED]	[REDACTED]
L2VPN	[REDACTED]	[REDACTED]
FR, ATM, IPS, PLS, NBIPVPN	[REDACTED]	[REDACTED]
VOIPTS, IPTeIS, CIPS	[REDACTED]	[REDACTED]
EthS	[REDACTED]	[REDACTED]
L2VPN,	[REDACTED]	[REDACTED]
FR, ATM, IPS, PLS, NBIPVPN	[REDACTED]	[REDACTED]
VOIPTS, IPTeIS, CIPS	[REDACTED]	[REDACTED]
EthS	[REDACTED]	[REDACTED]
L2VPN	[REDACTED]	[REDACTED]
FR, ATM, IPS, PLS, NBIPVPN	[REDACTED]	[REDACTED]
VOIPTS, IPTeIS, CIPS	[REDACTED]	[REDACTED]
EthS	[REDACTED]	[REDACTED]
L2VPN	[REDACTED]	[REDACTED]
FR, ATM, IPS, PLS, NBIPVPN	[REDACTED]	[REDACTED]
VOIPTS, IPTeIS, CIPS	[REDACTED]	[REDACTED]
EthS	[REDACTED]	[REDACTED]
L2VPN	[REDACTED]	[REDACTED]
FR, ATM, IPS, PLS, NBIPVPN	[REDACTED]	[REDACTED]
VOIPTS, IPTeIS, CIPS	[REDACTED]	[REDACTED]
EthS	[REDACTED]	[REDACTED]
L2VPN	[REDACTED]	[REDACTED]

Service		
FR, ATM, IPS, PLS, NBIPVPN	[REDACTED]	[REDACTED]
VOIPTS, IPTeIS, CIPS	[REDACTED]	[REDACTED]
EthS	[REDACTED]	[REDACTED]
L2VPN	[REDACTED]	[REDACTED]
FR, ATM, IPS, PLS, NBIPVPN	[REDACTED]	[REDACTED]
VOIPTS, IPTeIS, CIPS	[REDACTED]	[REDACTED]
EthS	[REDACTED]	[REDACTED]
L2VPN	[REDACTED]	[REDACTED]

As illustrated, Qwest has expedited our commercial development cycle to deploy our services, including integration of service, access, and commercial OSS, to provide the Government with full functionality upon contract award. Qwest continues to optimize and upgrade our commercial OSS capabilities by further automation and consolidation of management operations to gain efficiencies for customers. Qwest's Networkx service architecture is built on the same platforms and OSS supporting our commercial customers, thus ensuring that Networkx benefits from the continued evolution of our network architecture and OSS.

[REDACTED]

[REDACTED]

[REDACTED]

[REDACTED]

[REDACTED]

[REDACTED]

[REDACTED]

[REDACTED]

[REDACTED]

[REDACTED]

Qwest already has a clear approach and has made significant progress in deploying a network that not only enables convergence from the customer's perspective, but is also a highly converged platform. [REDACTED]

[REDACTED]

[REDACTED] Qwest has already converged our IP-based services (private port MPLS VPNs, public port for Internet services, and our VoIP transport for PSTN traffic) over this network.

Qwest is committed to the elimination of stove-piped networks that create planning, operations, and interoperability issues. [REDACTED] shows Qwest's approach to ensure that services have a uniform view of network and support infrastructure. Multiple overlay networks are no longer established to deliver new services. Value is shifted to network-based services, where Qwest becomes a solutions provider. Applications-based services are

[REDACTED]

delivered independent of the network infrastructure. Excellent service quality is maintained during network convergence through the following practices:

[REDACTED]

**Qwest Backbone Convergence:** [REDACTED] the use of a converged MPLS core significantly eases the problems normally associated with backbone traffic engineering. Without a converged backbone, each services network (for example, one for Internet, one for private IP services, and one for voice) needs to be traffic-engineered independently. This can lead to a state where one network has too much capacity and another has performance limitations that require a backbone or router upgrade. This can lead a carrier into a situation where the upgrade for one service network requires a large upgrade that is not cost-effective. For example, the desired upgrade from OC-48c to OC-192c backbone circuits may require a complete nationwide upgrade that the carrier cannot afford, forcing them to settle for suboptimal performance regarding SLA fulfillment.

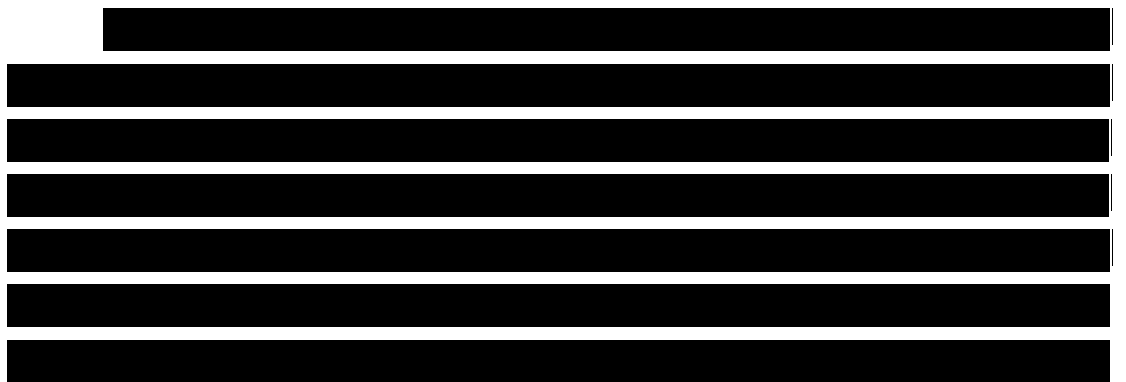
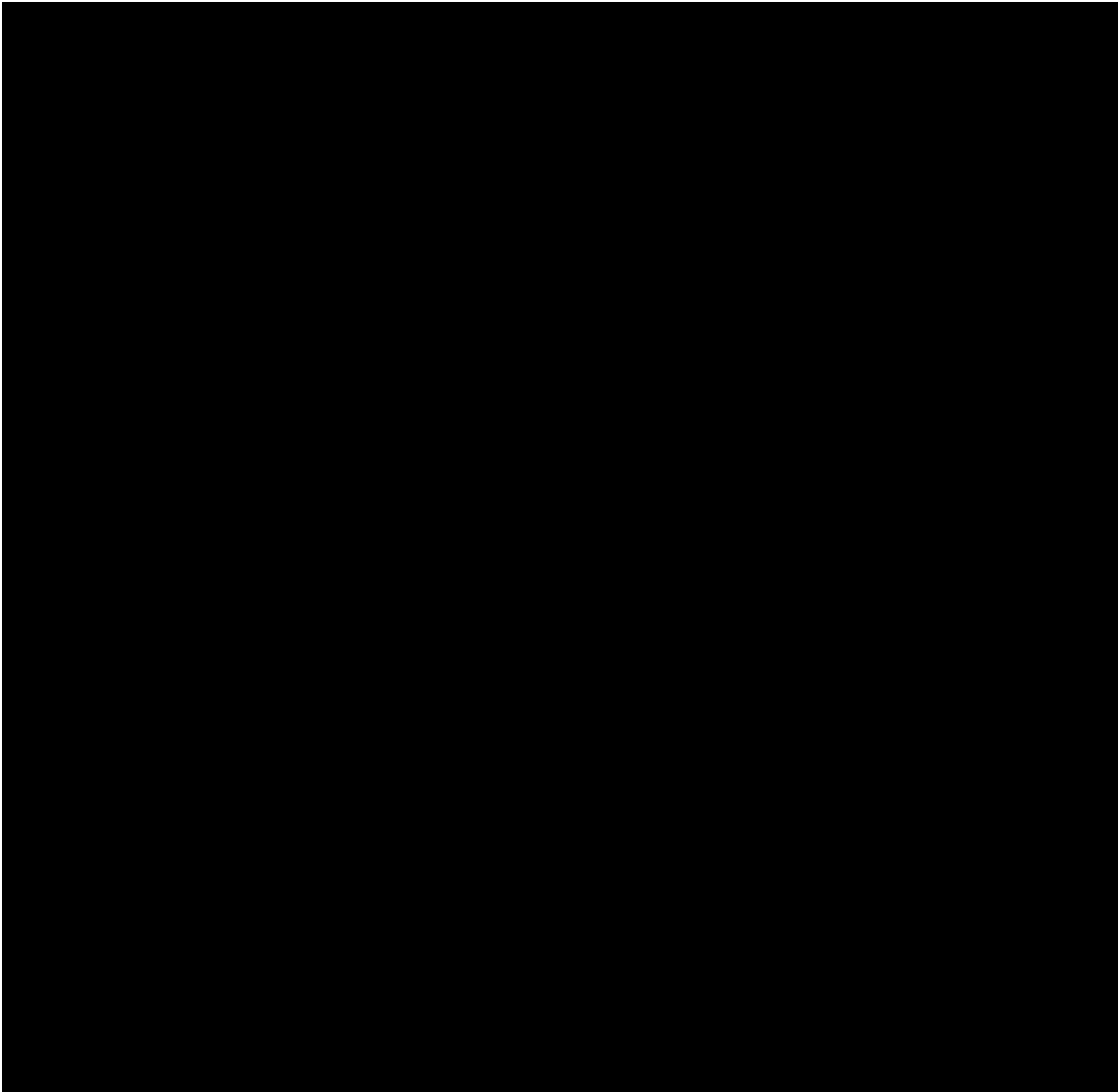



[REDACTED]

**Qwest Voice Network Convergence:** Using Next Generation switches, the voice network core is currently a hybrid of IP and TDM, offering the utmost in reliability and flexibility. Any call going through the network can be IP enabled, or it can transit purely on a TDM path. The Class IV TDM switches are connected to the nationwide voice network, thousands of customer PBXs and other Customer Premise Equipment (CPE). The IP network complies with the latest IP standards in communications, such as the latest VoIP protocols (e.g., Session Initiation Protocol (SIP)), compression algorithms and transcoding standards. Session Border Controllers (SBCs) have been deployed in the network to ensure proper security for our VoIP customers. All VoIP traffic must transit these SBCs.

**Qwest Edge Services Convergence:** With the backbone convergence technology in place, Qwest has focused on edge services and flexible access to those services. Early on, Qwest recognized that security can be a limitation for network convergence. Although MPLS VPN technologies allow for the logical partitioning of edge routers, a common edge router that provides both private MPLS VPN services and Internet service is, by its very nature, exposed to the Internet. Although there is logical separation, Qwest gathered input from security experts and our customers

and decided to deploy distinct edge routers for our private ports (which support Networkx NBIP-VPNS) and public ports (which support Networkx IPS) for Internet services.

[REDACTED]

**Qwest Access Services Convergence:** As described in Section 3.3.1, Qwest has also placed heavy emphasis on providing access solutions that enable converged services to the customer. As described earlier, access QoS is guaranteed by the size of the dedicated circuits assigned for each service. Of more interest is the use of dedicated ATM or FR access; ILEC ATM, FR and Ethernet services; and CLEC xDSL and Ethernet services. In each of these cases, [REDACTED]

[REDACTED]

Qwest will evolve and improve the overall quality of capabilities, service delivery and architectural requirements through continuous iteration.

Converged capabilities will be simple to understand and easy to use. Qwest's success will be measured by the quality of the customer experience.

**3.3.4 Integration of New Future Commercially Available Products/Services (L.34.1.3.3 (d))**

Qwest has mature processes used to research, evaluate, engineer, deploy and operate new or emerging services. Qwest evaluates new products and technologies for incorporation into the Qwest network. This process is managed by the Chief Technology Officer and Product Management.

[Redacted content]

[Redacted content]

[REDACTED]

Once the NTSC approves the risk analysis, a Field Verification Office (FVO) explores actual in-network issues. If the FVO is successful, Qwest develops a plan for full deployment, which includes a business case covering all aspects of the product such as equipment, operations and maintenance, Information Technology (IT) cost and revenue projections. Once approved by the NTSC's executive committee, various engineering and IT resources are engaged to develop and deploy the fully developed product.

The guiding principles for continued evolution of the Qwest network are:

[REDACTED]

[Redacted text block]

[Redacted text block]

[Redacted text block]

[Redacted text block]

[Redacted]	[Redacted]
[Redacted]	[Redacted]
[Redacted]	[Redacted]
[Redacted]	[Redacted]
[Redacted]	[Redacted]

### 3.3.5 Approach for Interoperability Between IP and PSTN (L.34.1.3.3 (e))

Qwest has extensive experience in integrating VoIP technology into the TDM PSTN. Qwest developed and integrated a VoIP switch into our IXC network, [REDACTED]

[REDACTED]

[REDACTED]

[REDACTED] This VoIP NGS is fully integrated to our existing TDM network switches via Inter-Machine Trunks (IMTs). Additionally the NGS offers dedicated TDM connectivity to the customer premises and has interconnect trunks with local exchange carriers. The VoIP traffic on our network is processed over our private MPLS core backbone ensuring [REDACTED]

[REDACTED] even in the event of a transport link failure. [REDACTED]

[REDACTED]

[REDACTED]

In addition to the replacement of standard TDM voice switches, Qwest has built a comprehensive set of VoIP services. These services provide wholesale and retail VoIP services directly to customers, enabling converged

access for Qwest data services and VoIP-based voice services. Session Border Controller (SBC) technology has been implemented to ensure the proper level of security is implemented in our peering arrangements with our wholesale and retail customers. Feature servers are used to effectively process IP originated calls or IP terminated calls to and from the PSTN network. Media servers are also used to add incremental value-added services to ensure feature parity with current PSTN offerings including E911.

[REDACTED]

In summary, Qwest fully expects to continue an evolution towards convergence of VoIP and legacy TDM platforms to provide fully integrated solutions. A full spectrum of VoIP services, providing local and long-distance services, is being fully converged with other services, including our Private MPLS network services and network-based firewalled access to the Internet.

**3.3.6 Approach for IPv4 – IPv6 Migration (L.34.1.3.3 (f))**

[REDACTED]



[Redacted text block]

[Redacted text block]

[Redacted text block]

